

NEW

CT RANGE

OF SHOWER PUMPS



WRAS
APPROVED
PRODUCT

ALSO AVAILABLE IN

BRASS

Salamander Pumps
Quality | Technology | Service | Value



Making
water
perform

NEW

Introducing the stunning new range of CT shower pumps; quiet, compact, reliable and now also available as brass ended, under the new CT FORCE branding

WHY CHOOSE CT Xtra OR CT FORCE?

Through the application of technologies developed for Salamander's impressive new HomeBoost™ product, we have delivered a range of improved shower pumps, packed with performance and innovation identified by using the new Tech₂ology inside logo and icons.



TECH₂OLOGY INSIDE

Salamander Pumps have developed a series of icons to help identify the technological innovations held within their products.

The CT Xtra and CT FORCE range incorporate four of these technologies.

THE BENEFITS:

The patented technologies used in the new CT Xtra and new CT FORCE ranges, are industry leading, and give both the consumer and installer excellent performance, and are easier to install.

- ✓ **More** pressure & flow
- ✓ **More** compact in size
- ✓ **Impressively** quiet
- ✓ **Easy** to install
- ✓ **Latest** TECH₂OLOGY INSIDE



SOLID STATE SWITCHING

- RELIABLE
- CONSISTENT
- ACCURATE



MOTOR PUMP INTEGRATION

- COMPACT SIZE
- AIDS COOLING
- LONGER LIFE



CROSSOVER

- ENABLES INDIVIDUAL OUTLET OPERATION
- RELIABLE
- INTEGRATED BYPASS

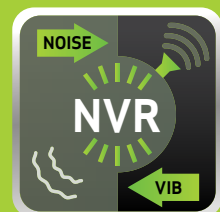

NOISE / VIBRATION REDUCTION

- NOISE REDUCTION
- VIBRATION REDUCTION

OUR FAMILY

Quality

Achievement of ISO9000 compliance reflects our commitment to delivering high quality in all facets of our business. All of our pumps are tested to ensure they are leak free and in full working order before leaving the factory.

Tech₂ology

Salamander have applied innovative and patented technologies throughout the new CT Xtra and CT FORCE shower pump range. The application of these technologies, identified and explained by the Tech₂ology logos and icons, has resulted in very compact pumps with exceptional quietness, impressive performance and improved efficiency.

Service

With decades of plumbing experience on our technical advice lines, and within our business, we have a team that is highly responsive to all customer service needs. Our service provision is second to none in our sector, and continues to be a major focus for Salamander Pumps.

Value

Our competitive pricing has helped drive our accelerated sales growth over the last decade, delivering Salamander to its position as one of the leading shower pump manufacturers in the UK today. We believe our pumps deliver outstanding value for money.

CT FORCE & CT Xtra RANGE

The stunning new range of CT pumps from Salamander, in either plastic or brass, positive and negative head (universal) variants.



HOMEBOOST

Giving your mains fed water supply the boost it needs. HomeBoost™ is an intelligent pump; it recognises when the flow is low and automatically boosts the performance of incoming mains water.



ESP RANGE

Universal, negative head shower and whole house pumps. ESP pumps use centrifugal technology enabling them to deliver outstanding pressure and flow with an incredibly quiet performance.



RSP/RHP RANGE

The RSP/RHP range of positive head pumps for both showering and whole house applications utilising centrifugal technology to deliver outstanding pressure and flow with an incredibly quiet performance.

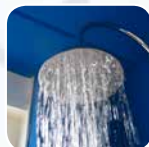
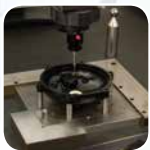

NEW

CT Xtra

The new CT Xtra range raises the bar for all other 'entry level' shower pumps to follow. With their advanced design features this new range of single and twin ended shower pumps will quietly and efficiently boost the hot and cold water supplies to thermostatic or manual mixer valves, and are suitable for a wide range of shower types and heads, making the new CT Xtra pumps the best value for money pumps available.

WHAT'S NEW?

The reduced noise operation emanates from the integration of an efficiently designed water way and impeller. Other improvements in the design have led to a greater flow and pressure performance, whilst the compact overall dimensions make installation a dream in tight spaces.

CT Xtra is also a fully **WRAS APPROVED PRODUCT**

THE RANGE:

CT50 Xtra
Bar Rating: 1.5

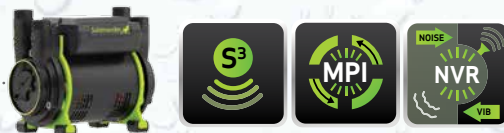

CT75 Xtra
Bar Rating: 2.0

CT55 Xtra
Bar Rating: 1.6

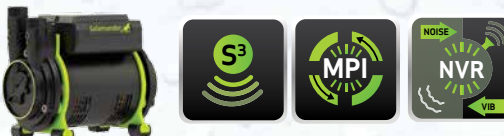

CT85 Xtra
Bar Rating: 2.1

VERY QUIET
exceptionally quiet performance

Delivers **MORE** pressure & flow than the old CT range

NEW
'laminar flow' float switch for accurate switch on

COMPACT SIZE
smallest shower pump, biggest performance - fits in tight spaces



CONSTANTLY RATED MOTOR
- improved efficiency from previous range

MODEL SHOWN:
CT50 Xtra

NEW

CT FORCE

The new high-quality and robust BRASS shower pump range from Salamander is available as twin or single ended, Positive Head or Universal models. The CT FORCE range is your ideal partner in boosting hot and / or cold supplies to thermostatic or manual mixer valves, supplying a wide range of shower types and shower heads, individual taps, cisterns and other appliances, and whole house boosting applications.

WHAT'S NEW?

With their new efficient water way design, solid brass impellers, robust brass pump bodies, and reduced noise generation, these new pumps exude reliability, quality and performance. The integrated bypass and pressure vessel further underlines the ruggedness of the Universal models, whilst the compact overall dimension makes installation a dream in tight spaces.

CT FORCE is also a fully **WRAS APPROVED PRODUCT**

THE RANGE:

CT FORCE 15 PT

Bar Rating: 1.5



CT FORCE 20 PT

Bar Rating: 2.0

CT FORCE 30 PT

Bar Rating: 3.0

CT FORCE 20 PS

Bar Rating: 2.1



CT FORCE 30 PS

Bar Rating: 3.1

CT FORCE 15 TU

Bar Rating: 1.5



CT FORCE 20 TU

Bar Rating: 2.0

CT FORCE 30 TU

Bar Rating: 3.0



CT FORCE 20 SU

Bar Rating: 2.1

CT FORCE 30 SU

Bar Rating: 3.1



VERY QUIET

exceptionally quiet performance

CONSTANTLY RATED MOTOR

improved efficiency from previous range

COMPACT SIZE

smallest shower pump, biggest performance - fits in tight spaces

Delivers

MORE

pressure & flow than the old FORCE range

NEW

'laminar flow' float switch for accurate switch on

SOLID BRASS

end caps / impellers for extra robustness



MODEL SHOWN:
CT FORCE 30PT

TYPICAL INSTALLATIONS

Installed in a variety of applications, delivering power to your shower or performance to all outlets in your home, Salamander Pumps make water perform.

As with all shower pumps, Salamander Pumps must only be installed on 'Gravity' systems, i.e. systems with a cold water cistern (usually sited in a loft) and a hot water cylinder (usually in an airing cupboard) feeding the hot and cold inlets of the pump. A typical installation diagram is shown below.

SYSTEM IDENTIFICATION

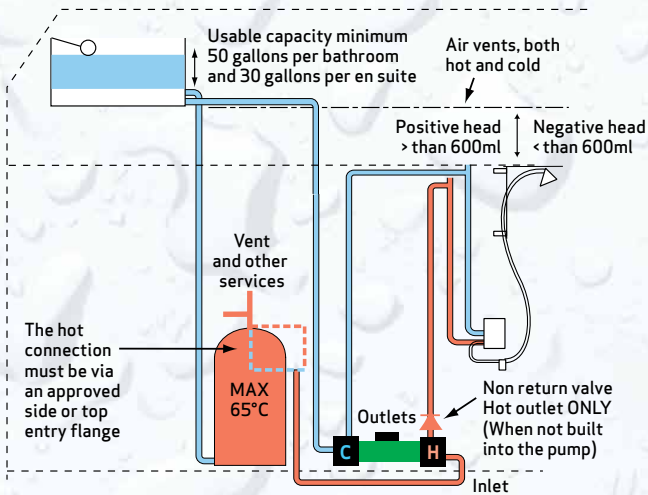

It is also necessary to identify if the outlet (shower, tap, toilet etc.) you wish to power is in 'negative' or 'positive' head. An outlet is in 'positive head' where it and any pipework feeding it, is a minimum of 600mm below the cold water storage tank; as such any of the CT Xtra / CT FORCE range can be installed. Conversely, where the outlet or any pipework feeding it, is less than 600mm below the cold water storage tank, then the outlet is in negative head, requiring the use of one of Salamander's high-quality universal pumps.

When correctly installed, a Salamander shower pump will provide many years of trouble-free power to your shower, or make your water perform throughout your home.

The CT Xtra and CT FORCE ranges come with a 2 and 3 year warranty respectively. Both ranges can have their warranties extended by contacting our Pumpwise helpline, and having the installation approved.

TYPICAL FLOW CURVES

CT FORCE

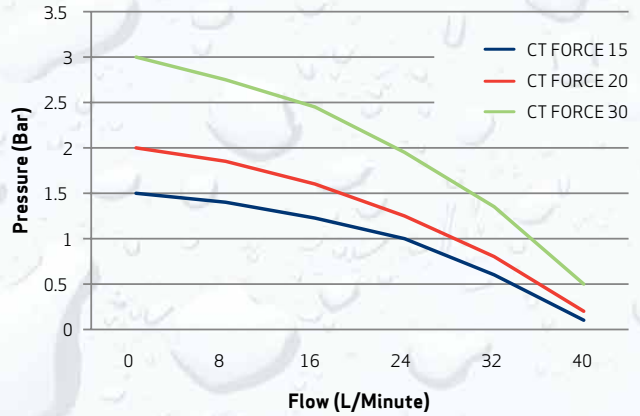

CT Xtra

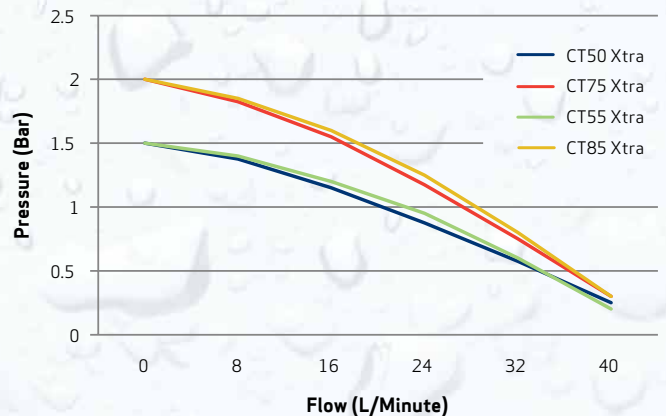

PUMP DIMENSIONS

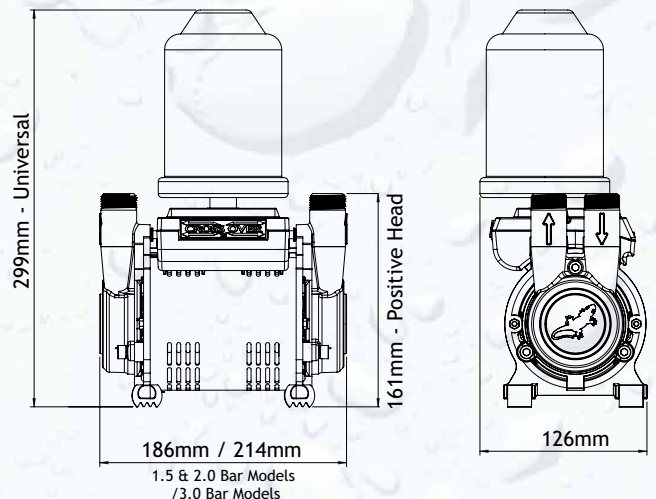

For further installation guides please visit www.salamanderpumps.co.uk/downloads

or scan the QR code on the right using a smartphone and QR code reader app.



THE NEW CT RANGE

1.5 - 1.8 Bar IDEAL FOR 1 SHOWER OR 1 OUTLET

	Performance		Application				Specification			Configuration	Connection Size / Type				List Price £ (ex Vat)				
	Bar Rating Closed Head	Bar Rating @ 8 Ltr/min	Shower Only	Whole House	Positive Head	Universal/ Negative Head	Individual Taps/ Outlets	Motor			Seal	Pump	Hose			Isolators			
								Continuously Rated Induction Motor	Composite				Brass	Carbon		Pushfit	Diameter	Inlet	Outlet
CT50 Xtra	1.5	1.4	●		●			●	●	●	G3/4 (m)	15mm	1.5mm			£162.25			
CT55 Xtra	1.5	1.4			●		●	●	●	●									£153.50
CT50 + Xtra	1.5	1.4	●		●		●	●	●	●						●			£184.25
CT55 + Xtra	1.5	1.4			●		●	●	●	●						●			£163.75
CTFORCE 15PT	1.5	1.3	●	●	●		●		●	●					22mm		●	●	£375.00
CTFORCE 15TU	1.5	1.3	●	●		●	●		●	●							●	●	



CT50 Xtra /+



CT55 Xtra /+



CT FORCE 15 PT



CT FORCE 15 TU

2.0 - 2.5 Bar IDEAL FOR 1 SHOWER + 1 OUTLET

	Performance		Application				Specification			Configuration	Connection Size / Type				List Price £ (ex Vat)				
	Bar Rating Closed Head	Bar Rating @ 8 Ltr/min	Shower Only	Whole House	Positive Head	Universal/ Negative Head	Individual Taps/ Outlets	Motor			Seal	Pump	Hose			Isolators			
								Continuously Rated Induction Motor	Composite				Brass	Carbon		Pushfit	Diameter	Inlet	Outlet
CT75 Xtra	2.0	1.7	●		●			●	●	●	G3/4 (m)	15mm	1.5mm			£215.25			
CT85 Xtra	2.5	2.3			●		●	●	●	●									£190.50
CT75 + Xtra	2.0	1.7	●	●	●		●	●	●	●						●			£225.50
CT85 + Xtra	2.5	2.3		●	●		●	●	●	●						●			£203.00
CT FORCE 20PT	2.0	1.7	●	●	●		●		●	●					22mm		●	●	£395.00
CT FORCE 20PS	2.0	1.7		●	●		●		●	●							●	●	
CT FORCE 20 TU	2.0	1.7	●	●		●	●		●	●			●	●		£545.00			
CT FORCE 20 SU	2.0	1.7	●	●		●	●		●	●			●	●		£385.00			



CT75 Xtra /+



CT85 Xtra /+



CT FORCE 20 PT



CT FORCE 20 PS



CT FORCE 20 TU



CT FORCE 20 SU

3.0 Bar IDEAL FOR 2 SHOWERS + 2 OUTLETS

	Performance		Application				Specification			Configuration	Connection Size / Type				List Price £ (ex Vat)				
	Bar Rating Closed Head	Bar Rating @ 8 Ltr/min	Shower Only	Whole House	Positive Head	Universal/ Negative Head	Individual Taps/ Outlets	Motor			Seal	Pump	Hose			Isolators			
								Continuously Rated Induction Motor	Composite				Brass	Carbon		Pushfit	Diameter	Inlet	Outlet
CT FORCE 30PT	3.0	2.5	●	●	●			●		●	G3/4 (m)	22mm	1.5mm		●	●	£450.00		
CT FORCE 30PS	3.0	2.5	●	●	●		●		●	●						●	●		£285.00
CT FORCE 30TU	3.0	2.5	●	●		●	●		●	●						●	●		£595.00
CT FORCE 30SU	3.0	2.5	●	●		●	●		●	●						●	●		£395.00



CT FORCE 30 PT



CT FORCE 30 PS



CT FORCE 30 TU



CT FORCE 30 SU



Salamander Pumps

Quality | Technology | Service | Value

Salamander Pumps are manufactured in the UK from top quality components, the majority of which are sourced from the EU.

Each component is extensively tested for long life and every pump is subject to strict quality controls before it leaves our factory in Sunderland.

Salamander Pumps have developed a highly professional and responsive service support team for its customers. Whether that support is for pre-installation advice or advice on which pump best fits the customers needs, or to address any post installation issues that may occur, then our friendly and helpful staff are on hand via Pumpwise.

Pumpwise
0191 516 2002

All Salamander Pumps come with comprehensive installation guidelines to support a trouble-free installation.

When installed in accordance with those guidelines, we are confident that you will enjoy trouble-free ownership of your Salamander pump for many years to come.



Salamander Pumps Shower Systems Limited

Unit 2c Colima Avenue, Enterprise Park West,
Sunderland, SR5 3XE

Telephone: 0191 516 2002
Facsimile: 0191 548 4445
Email: sales@salamanderpumps.co.uk

www.salamanderpumps.co.uk

