



Scan this QR code to go to information for Advance Heatloop and Waste Water Heat Recovery Systems (WWHRS) or visit www.mirashowers.com

Mira Advance Heatloop

THERMOSTATIC
ELECTRIC SHOWER

8.7 kW

Designed for use with Waste Water Heat Recovery Systems (WWHRS)

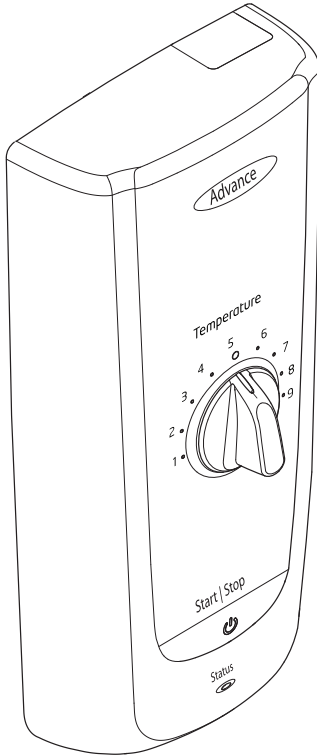

R N I B

Tried and Tested

For **SPARES, ADVICE** or **REPAIRS** please call us free on **0800 001 4040** (UK only)

These instructions must be left with the user

Installation & User Guide

Showering perfection

mira
SHOWERS

Important Safety Information

Warning! This shower can deliver scalding temperatures, cause fire, electric shock or other personal injury if not operated, or maintained in accordance with the instructions, warnings and cautions contained in this guide and on the appliance.

Please read the important safety information and the operation section of this guide before using the shower. Failure to follow the information or instructions provided on or with this shower will invalidate the guarantee.

Warning! The shower head and hose supplied with this product are critical to its correct operation. When installing or exchanging an electric shower always fit and use the shower head and hose provided with the product.

If any future change of the shower head or hose is required only fit suitable Mira manufactured products. Non-Mira manufactured shower heads may not be suitable for electric showers. They can be very restrictive or stop the flow of water, this is dangerous and could lead to product damage, scalding or serious injury.

If you are unsure about the shower head and hose compatibility with your shower contact Mira Customer Services.

TO REDUCE THE RISK OF FIRE, ELECTRIC SHOCK OR INJURY:

1. Children younger than 3 years should not use this shower. Children 3 years to under 8 years should only use this shower under continuous supervision. Children aged 8 years and above and persons with reduced physical, sensory or mental capabilities or lack of experience or knowledge can use the shower if they are given supervision or instruction concerning use of the appliance in a safe way and understand the hazards involved.
2. Children shall not be allowed to play with the shower.
3. Cleaning and user maintenance shall not be made by children.
4. **DO NOT** restrict the water flow from the shower outlet, temporarily bending the shower hose or blocking the shower head, such as placing against your body while in use can cause a very hot shot of water to be discharged.

5. The outlet must not be connected to any tap or fitting other than those specified.
6. The showerhead must be descaled regularly. Any blockage of the showerhead or hose can cause injury or scalding.
7. **Warning! DO NOT** switch on if there is a possibility that the water in the shower is frozen.
8. **Warning!** If the shower has symptoms of low or no flow from the outlet, immediately turn it off and **DO NOT** operate the shower. Any further diagnosis must be carried out with the power control set to low and the temperature control set to full cold (see **Commissioning**).
9. This shower must be provided with means for local disconnection that is incorporated into the fixed wiring in accordance with the relevant local wiring regulations. This must be a double pole switch, which has at least 3 mm contact separation in each pole. The switch can be a ceiling mounted pull-cord type within the shower room or a wall mounted switch fitted in the applicable zone area.
10. Installation of the shower must be carried out in accordance with these instructions by qualified, competent personnel. Read all instructions before installing the shower.
11. **DO NOT** switch the shower on if water starts leaking from the shower case. Isolate the electrical supply to the shower immediately.
12. **DO NOT** switch the shower on if the case appears to be damaged or incorrectly fitted. Isolate the electrical supply to the shower immediately.
13. **DO NOT** increase the power setting or adjust the temperature control rapidly while using the shower. Move away from the shower and ensure the temperature has stabilised before re-entering the shower.
14. **DO NOT** switch the shower off and back on while standing in the water flow. Move away from the shower and ensure the temperature has stabilised before re-entering the shower.
15. **DO NOT** change the handset model. Fit only shower heads recommended by Mira and do not fit any additional device to restrict the water outlet flow.

16. When adjusting the handset mode, point handset away from body and make sure that the water temperature has stabilised before continuing to shower.
17. Use caution when altering the water temperature, always check the temperature before continuing to shower.
18. Switch the shower off at the electrical isolating switch when not in use. This is recommended with all electrical appliances.
19. Isolate the electrical and water supplies before commencing installation. The electricity must be isolated at the consumer unit and the appropriate circuit fuse removed, if applicable. Mains connections are exposed when the cover is removed.
20. **DO NOT** install the shower in areas with high humidity and temperature (i.e. Steam rooms and saunas).
21. **DO NOT** install the shower where it may be exposed to freezing conditions. Ensure that any pipework that could become frozen is properly insulated.
22. **DO NOT** connect the outlet of the shower to any tap, control valve, trigger operated handset or showerhead other than those specified for use with this shower as the outlet acts as a vent for the tank body. Only Kohler Mira recommended accessories should be used.
23. **DO NOT** perform any unspecified modifications, or drill or cut holes in the product other than instructed by this guide. When servicing only use genuine Kohler Mira replacement parts.
24. This shower is designed to be connected to a WWHR system which will deliver a warmed inlet supply. **DO NOT** take a connection to any other appliance from the inlet supply of this shower.
25. All water system designs should consider potential risk of bacteria/legionella growth. To reduce biofilm formation, it is highly recommended that the water supplies from the outlet of the WWHR system to the Mira Advance Heatloop shower are connected using copper pipework rather than plastic. Reducing biofilm build up will help reduce the growth of bacteria.
26. As showers within domestic properties are used frequently, systems are flushed more often which helps in the prevention of bacterial growth. However, it is recommended to operate the product regularly in periods of non use and clean/descale shower heads and hoses at least every 3 months to reduce build up.

27. Always check the water temperature is safe before entering the shower.
28. The water supply to this product must be isolated if the product is not to be used for a long period of time. If the product or pipework is at risk of freezing during this period they should also be drained of water.
29. If the shower is dismantled during installation or servicing then, upon completion, an inspection must be made to ensure all electrical connections are tight and that there are no leaks.
30. This appliance is intended to be permanently connected to the water mains and not connected by a hose set.
31. The water inlet of this appliance shall not be connected to a water supply obtained from any other water heating system other than a WWHR system.
32. **Warning!** This appliance is not to be used to provide a potable water supply.
33. Maximum Static Pressure is 1000 kPa (10 bar).
34. Minimum Dynamic Pressure is 100 kPa (1 bar).

Introduction

Thank you for choosing a Mira shower. To enjoy the full potential of your new shower, please take time to read this guide thoroughly, and keep it handy for future reference. Products manufactured by Kohler Mira Ltd are designed to be safe, provided that they are installed, used and maintained in good working order, in accordance with our instructions and recommendations.

Follow all warnings, cautions and instructions contained in this guide, and on, or inside the shower. This guide is also available in digital format from our website or by contacting customer services.

Products Covered

Product Variant		Adjustable Temperature Limit	WWHR System Compatible	Model No.
Heatloop	8.7 kW	✓	✓	J09W

Recommended Usage

Domestic	✓	Light Commercial	✓
Heavy Commercial	✗	Healthcare	✗

This product is classified as suitable for Domestic and Light Commercial Use with a WWHR system, for installation in the UK only. For installation outside of the UK please contact Mira Showers/Rada for advice on suitability.

- Domestic = Household use in ordinary domestic premises
- Light Commercial = Residential Setting e.g. Accommodation covering student let/halls, hotels, guest houses, hostels

For healthcare, please visit mirashowers.com for suitable BEAB approved Advance products.

Guarantee

For **domestic installations**, Mira Showers guarantee the Mira product against any defect in materials or workmanship for a period of **two years** from the date of purchase (shower fittings for one year).

For **non-domestic installations**, Mira Showers guarantee the Mira product against any defect in materials or workmanship for a period of **one year** from the date of purchase. For Terms and Conditions refer to the back cover of this guide.

Product Compatibility

This product is designed for use with a Waste Water Heat Recovery System (WWHRS). It is recommended to be installed with ReCoup systems.

Visit www.recoup.co.uk

Pack Contents

Tick the appropriate boxes to familiarise yourself with the part names and to confirm that the parts are included.

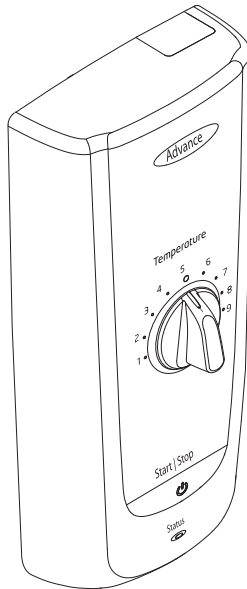

1 x Mira Advance Heatloop



1 x Compression Nut



2 x Fixing Screws



1 x Olive

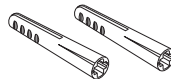

2 x Wall Plugs

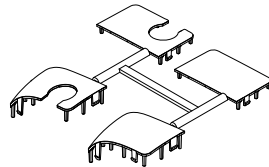

1 x Cover Insert

The product is not supplied with WWHRS.

Documentation

1 x Installation & User Guide

1 x Guarantee Card

1 x Installation Template & Energy Label

Specifications

Plumbing Supply	Supply Source	Mains pressure cold water via WWHRS	
	Minimum Dynamic Pressure*	100 kPa (1 bar)	
	Maximum Dynamic Pressure	500 kPa (5.0 bar)	
	Maximum Static Pressure	1000 kPa (10 bar)	
	Minimum Static Pressure**	20 kPa (0.2 bar)	
	Maximum Inlet Temperature***	35°C	
	Minimum Inlet Temperature	2°C	
	Inlet Connection	½" BSP male and 15 mm compression fitting.	
	Outlet Connection	½" BSP male fitting	
Electrical Supply	Nominal Rating at 230 V	8.0 kW	
	Nominal Rating at 240 V	8.7 kW	
	Supply Fuse/Circuit Breaker	8.7 kW	40 Amps
	Residual Current Device RCD	30 mA	
	Supply Cable	No larger than 16 mm ² Note: Refer to current IEE regulations and BS 7671 to determine minimum cable size.	
	Isolation Switch	45 Amp Double pole, with 3 mm contact separation.	
Maximum Ambient Temperature		30°C	
Minimum Ambient Temperature		2°C	
Ingress Protection Rating / IPX4			
Dimensions (shower unit)			
Height		408 mm	
Width		187 mm	
Depth		Heatloop 105 mm	

* Required dynamic pressure of 100 kPa (1.0 bar) for full flow performance.

** Static pressure must never fall below 20 kPa (0.2 bar) when other draw offs are in use, e.g. flushing toilet. This is the minimum pressure required to keep the flow valve closed.

*** This product is for use with mains pressure WWHRS and is specifically designed to accept preheated cold water up to 35°C.

UK & EU Conformity Information

The Mira Advance Heatloop complies with the requirements of BEAB and the relevant directives & regulations for UKCA & CE marking.

This product is in conformity with the relevant statutory requirements applicable to the product:

UK Legislation:

- S.I. 2016/1091 Electromagnetic Compatibility Regulations
- S.I. 2016/1101 Electrical Equipment (Safety) Regulations
- S.I. 2012/3032 Restriction of the Use of Certain Hazardous Substances in Electrical and Electronic Equipment
- S.I. 2010/2617 The Ecodesign for Energy-Related Products and Energy Information Regulations

EU Legislation:

- 2014/35/EU - Low Voltage Directive (LVD)
- 2014/30/EU - Electromagnetic Compatibility Directive (EMC)
- 2011/65/EU - Restriction of Hazardous Substances Directive (RoHS)
- (EU) No 814/2013 - Ecodesign requirements for water heaters and hot water storage tanks

This range of electric showers are high power appliances and are subject to conditional connection. If the main electrical supply fuse is rated less than 80 Amps, the local electricity supply company must be contacted to confirm if the electrical supply is adequate.

This range of showers complies with the requirements of the UK's water regulations.

Disposal and Recycling

End of Product Life

Electrical and electronic devices contain a range of materials that can be separated for recycling and used in new products.



This product should not be disposed of with your general household waste. When this product has reached the end of its serviceable life, please remove any batteries and take it to a recognised WEEE (Waste Electrical and Electronic Equipment) collection facility such as your local civic amenity site for recycling.

Your local authority or retailer will be able to advise you of your nearest recycling facility.

Eco-Design/Energy Labelling

Product Information

Indicative annual electricity consumption (kWh), based upon 2100 kWh daily energy demand. Actual electricity consumption will depend on kW rating and the duration and frequency of use.

	Mira
	Advance Heatloop
	8.7 kW
Load Profile	XS
Efficiency Class	A
Efficiency (%)	39.2
Annual Electricity Consumption (kWh)	471
Sound Power Level (dB)	15

Tools Required

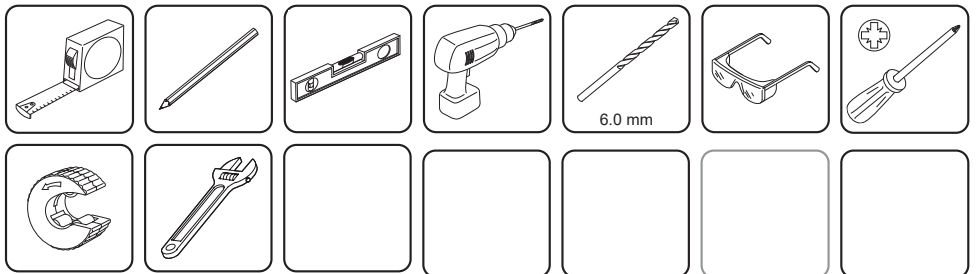

Installation Requirements

General

We recommend that the product be brought into the room where it is to be installed and left to acclimatise to room temperature, this will reduce the possibility of condensation on electronic components.

The shower works best when water supply conditions are stable and within the specifications, refer to section '**Specifications**'. If the supply conditions fall outside the specifications, the shower may go into a safe shut down condition.

The shower is designed to be connected to a WWHRS which will deliver higher incoming temperatures. Ensure the shower is correctly installed and follow all commissioning details. Failure to do so may effect the showers efficiency.

DO NOT connect the outlet of the shower to any tap, on/off control valve, trigger operated showerhead or any other showerhead other than those specified for use with this shower. This could cause scalding or severe damage to the product and will invalidate the guarantee. Only Kohler Mira recommended showerheads, shower hoses and accessories must be used.

This product is not suitable for connection to a shower waste drain pump unless it is designed as an integral part of a manufactured WWHRS.

If pipework and/or electrical cables enter the shower from the rear through a hole in the wall, provision must be made to prevent water ingress back into the wall structure. Ensure that the distance for inlet supply pipework and waste water supply from the shower to the WWHRS is kept to within 3 meters to reduce any heat losses and ensure maximum efficiency is maintained.

Route cable and pipe supplies via the cut outs moulded in the case and cover.

DO NOT perform any unspecified modifications to the shower or its accessories. Drilling fixing holes or making water or electrical entry points outside of the showers designed areas can lead to uncontrolled water ingress. This could cause fire, electrocution or damage to the product and will invalidate the product guarantee. When servicing only use genuine Kohler Mira replacement parts.

DO NOT increase the size or cut alternative pipe / cable entry points as water ingress into the product may occur.

After completing the installation be careful when cleaning. Many household and commercial cleaners, including tile cleaners and hand/surface cleaning wipes contain abrasives and chemical substances that can damage plastics, plating and printing and should not be used. These finishes should be cleaned with a mild washing up detergent or soap solution, and then wiped dry using a soft cloth.

The Mira Advance Heatloop is specifically designed for use with a WWHRS.

If an installed Advance Heatloop is being replaced, only exchange it with another Advance Heatloop shower or another shower suitable for use with a WWHRS.

Only connect one shower and one waste supply to a WWHRS.

Refer to the WWHRS instructions when installing the Mira Advance Heatloop.

Plumbing

Refer to section: 'Important Safety Information' first.

1. The plumbing installation must comply with all national or local water regulations and all relevant building regulations, or any particular regulation or practice specified by the local water supply company.
2. **DO NOT** use any other shower fittings. Only install and use the shower hose and handset provided with this product.
3. **DO NOT** use sealing compounds on any pipe fitting or joints.
4. To avoid damage to the case when soldered fittings are used, pre-solder the pipework and fittings before connecting them to the inlet connector assembly.
5. This appliance is designed to have a warmed inlet water supply from a WWHRS. **DO NOT** connect the shower to any other hot water supplies or gravity/pumped systems.
6. Make sure to clearly mark the preheated pipework along its length to indicate that it carries preheated water. This will help prevent it from being accidentally connected to other services in the future. It is also recommended to insulate the pipework to maintain the incoming temperatures to the shower inlet.
7. If the pressure exceeds the maximum specified then a drop tight pressure reducing valve (PRV) must be fitted. This should be sited as close to the incoming mains stopcock and ideally set to 3.5 bar.
8. Avoid layouts where the shower hose will be sharply kinked. This may reduce the life of the hose.
9. Supply pipework **MUST** be flushed to clear debris before connecting the appliance. Debris will reduce the performance of the shower and may damage the product. Avoid running the pipework through excessively hot or cold areas such as hot loft spaces, airing cupboards, or in close proximity to hot water pipes.
10. The shower must be fitted onto a tiled or sealed finished surface i.e. on top of tiles. **DO NOT** tile up to the sides of the shower or use a sealant around the case. Failure to do this may cause appliance failure. To ensure the case and other components are not put under strain during installation always provide mechanical support when making plumbing connections. Upon completion of the installation ensure connections and back case are not under any stress due to misaligned pipework or electrical cables.
11. We recommend that a non-restrictive (free flowing) isolating valve is fitted in the cold water supply pipe to allow maintenance of the appliance.
12. When installed in very hard water areas (above 200ppm temporary hardness) your installer may advise the installation of a water treatment device, to reduce the effects of limescale formation. Any malfunction due to limescale is not covered by the manufacturer's guarantee. Your local water company will be able to advise the hardness of water in your area.

13. Wall fixings are supplied for solid wall structures. For other wall structures such as wall panels alternative fixings may be required. A minimum of 2 fixing screws must be used.
14. The position of the shower and shower fittings must provide a minimum gap of 25 mm between the showerhead and the spill over level of any bath, shower tray or basin and a minimum gap of 30 mm between the showerhead and the spill over level of any toilet, bidet or other appliance with a Fluid Category 5 backflow risk.

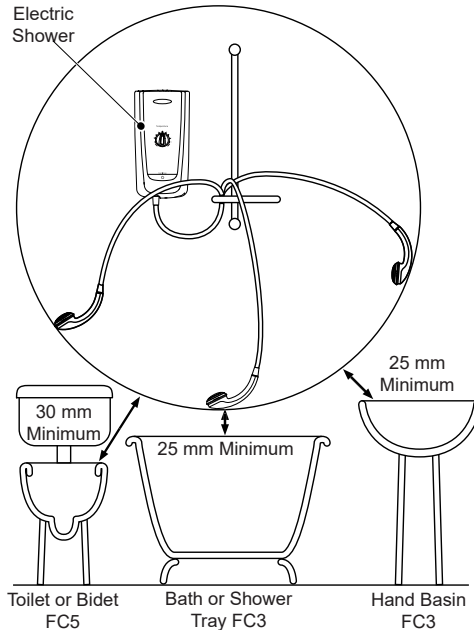

Hose Retaining Ring fitted and shower fittings fixed at a suitable height preventing dirty water backflow.

Note: There will be occasions when the hose retaining ring will not provide a suitable solution for Fluid Category 3 installations, in these instances an outlet double checkvalve must be fitted, this will increase the required supply pressure typically by 10kPa (0.1 bar). Double check valves fitted in the inlet supply to the appliance cause a pressure build up, which affect the maximum static inlet pressure for the appliance and must not be fitted. For Fluid category 5 double check valves are not suitable.

Electrical

Refer to section: 'Important Safety Information' first.

1. In a domestic installation, the rating of the electricity supplier's fuse and the consumer unit must be adequate for the additional demand. All Mira Advance electric showers are high power appliances. Voltage drop due to local heavy demand will reduce the shower's performance.
2. The appliance must be earthed by connecting the supply-cable earth conductor to the earth terminal. Any supplementary bonding and supply cable size must conform to BS 7671.
3. As a guide only, and in accordance with BS 7671 we recommend close circuit protection:
i.e. **8.7 kW = 40 Amp**
4. For new installations a 30 mA Residual Current Device (RCD) must be incorporated into the electrical supply to the shower in accordance with the current wiring regulations. When replacing an existing electric shower we recommend that a 30 mA RCD is incorporated in accordance with current wiring regulations if not already provided.
5. A separate, permanently connected supply must taken from the consumer unit to the appliance through a double-pole switch, which has at least 3 mm contact separation. The switch can be a ceiling mounted pull cord type within the shower room or a wall mounted switch in the applicable zone area.
6. **DO NOT** exert strain on the terminal block. Make sure that the electrical connections are tightly screwed down.
7. **DO NOT** turn on the electrical supply until the plumbing has been completed.
8. Unless otherwise stated, electrical equipment such as extractor fans, pumps must not be connected via this product.

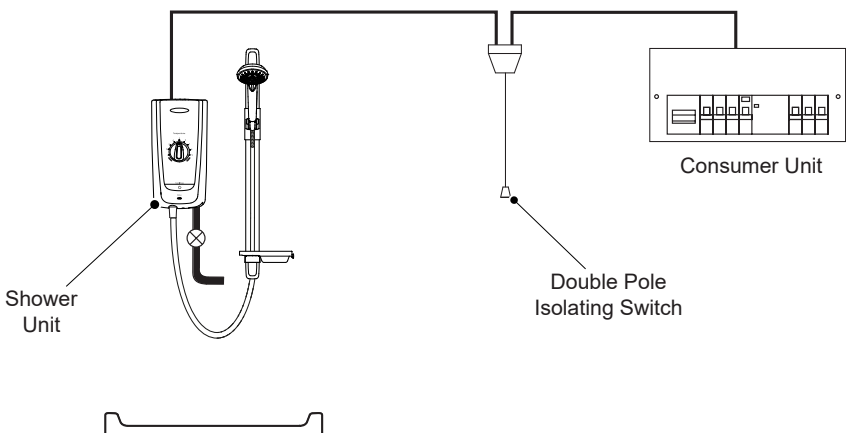

Electrical Schematic Diagram

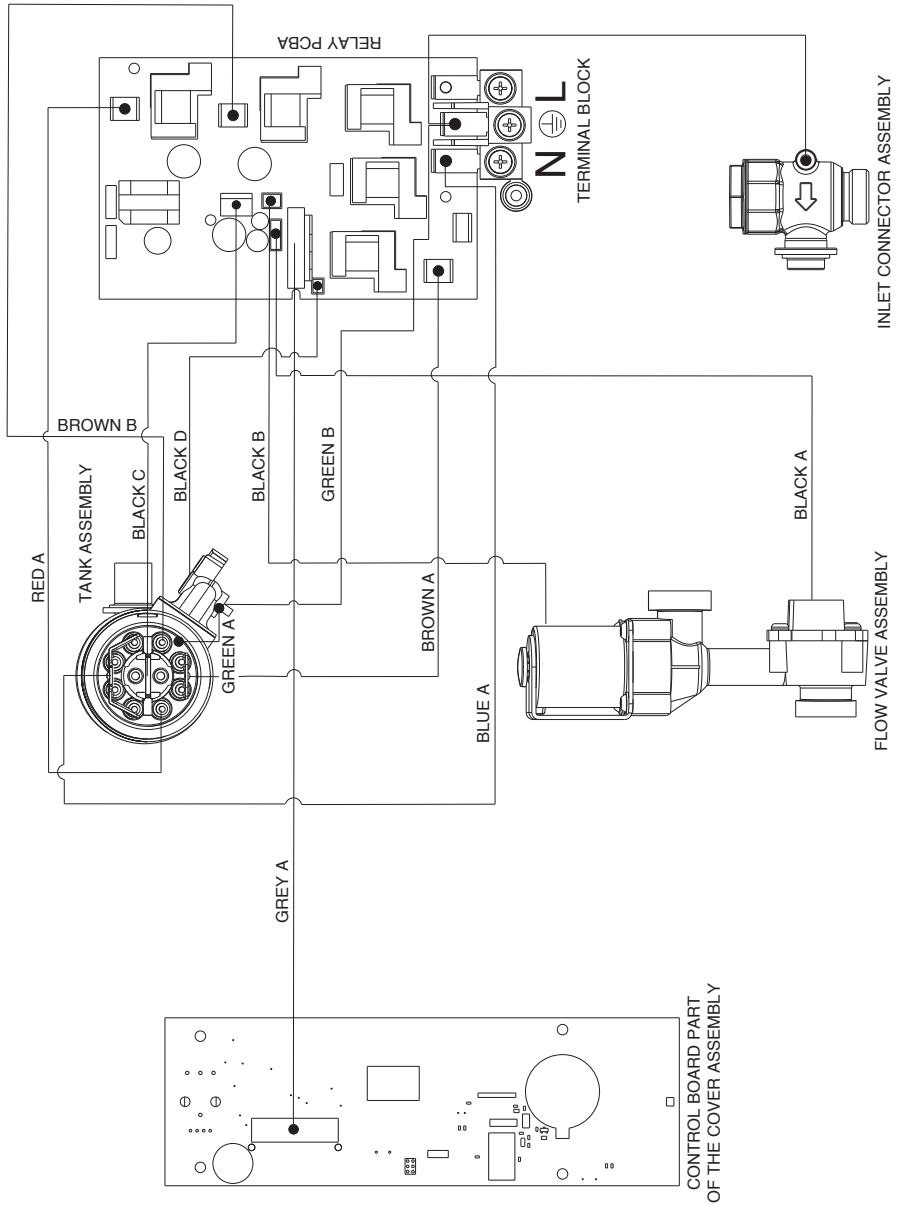

Shower Unit Wiring Diagram

Installation with a Waste Water Heat Recovery System (WWHRS)

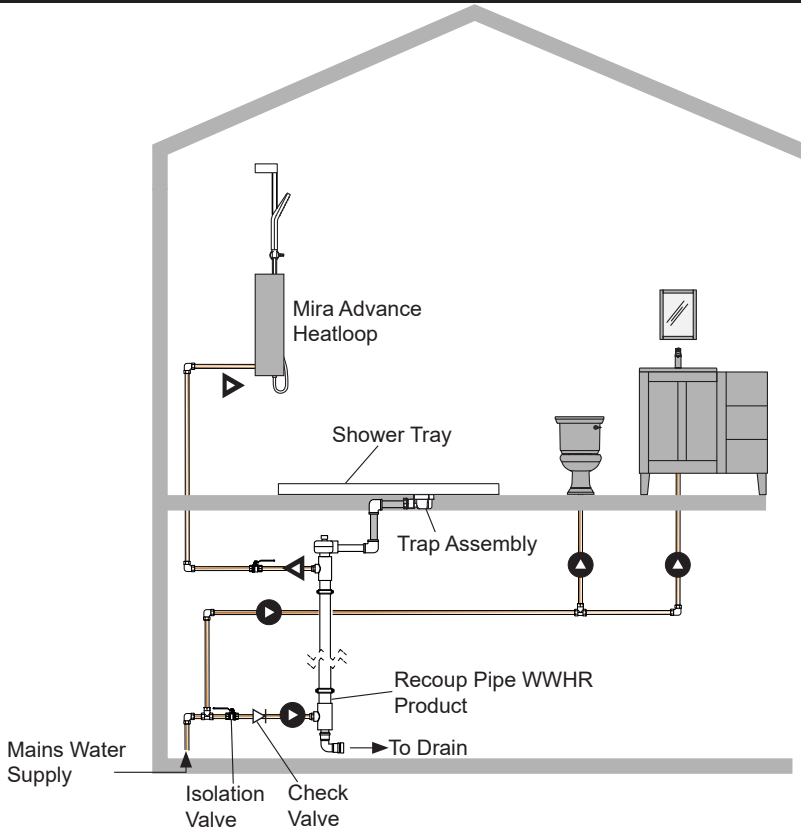

The preheated water is transferred to the Advance Heatloop shower only.

▶ Cold Water

▶ Preheated Water

⏏ Double Check Valve (This must be installed (not supplied))

Decide on a suitable position for the shower unit and fittings leaving adequate space for maintenance. A suitable position for the shower will have a minimum clear distance of 100 mm around the shower unit to allow for cover removal and refitting. See ***“Installation - Plumbing”*** for further details.

Note: Keep the length of the pipework from the WWHRS product as short as possible and no longer than 4.7 m. Ensure it is lagged to reduce heat loss and maximise efficiency.

Carefully follow all instructions for the WWHRS product guide. Failure to do so may affect the performance of the Mira Advance Heatloop.

Advance Heatloop Installation



Warning! Isolate the electrical and water supplies before installing the shower.

1

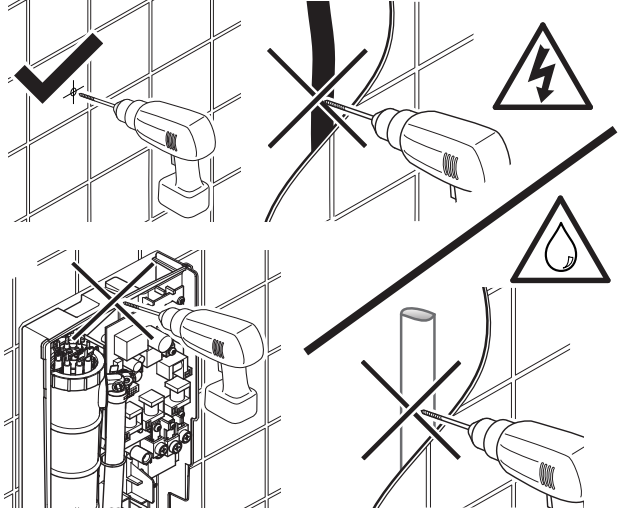
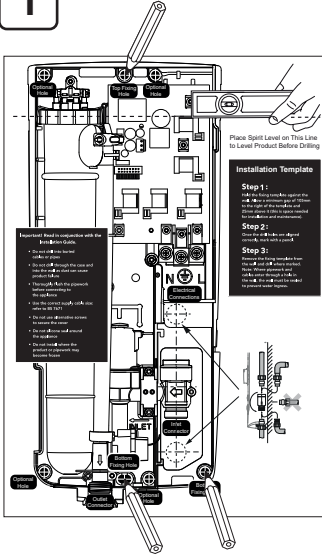

Use the installation template provided to mark and drill the required fixing holes.

DO NOT drill through the shower unit into the wall. Plaster and brick dust will damage the internal components of the product.

DO NOT drill into buried cables or pipes.

Note: Make sure that you mark a minimum of two fixing holes, one at the top and one at the bottom.

2

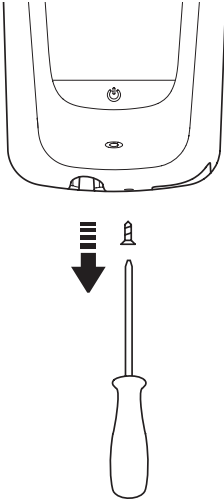

Remove the cover screw.

3

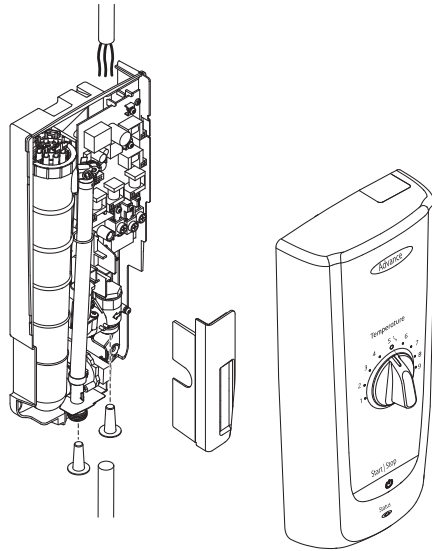

Remove the cover, the service tunnel and the bungs.

4

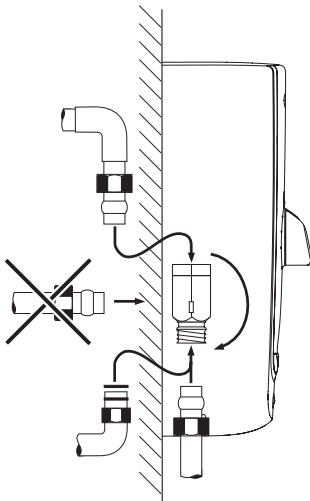

Turn the inlet connector to suit supply pipe. **DO NOT** trap the green wire.

5

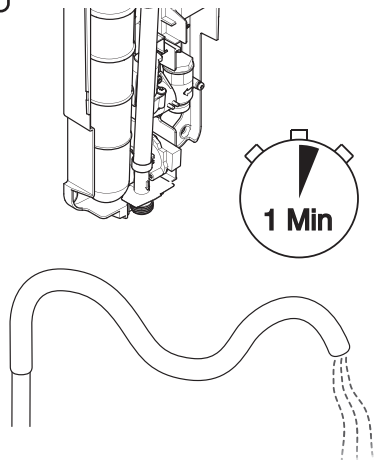

Flush the pipework for approximately 1 minute prior to connection.

6

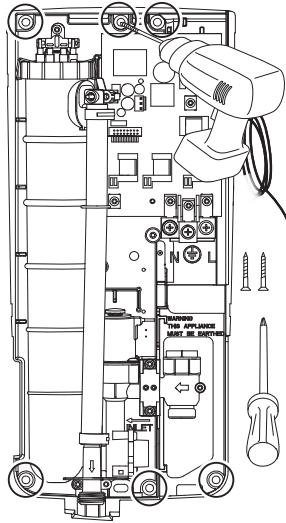

Drill the fixing holes through the plastic case in the designated areas as required.

DO NOT drill through the shower unit into the wall.

Fix the appliance to the wall.

Use appropriate screws and wall plugs for fixing.

Note: Make sure that the product is securely fixed to the wall.

7

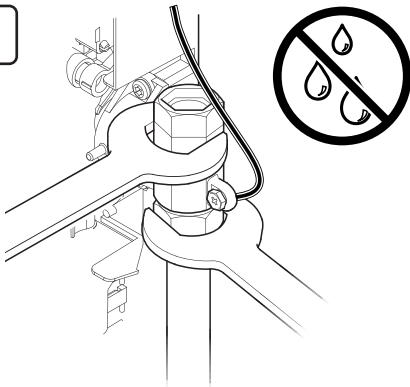

Connect supply pipe, then turn the water supply on and check the shower unit for leaks. **DO NOT** overtighten.

8

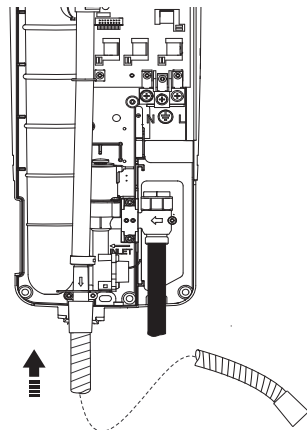

Connect the hose pointing into the bath or tray.

Note: Make sure that the hose washer is fitted.

DO NOT fit the shower head at this stage.

9 Important! Priming the Shower

Make sure that the electrical supply is isolated!

To prime the appliance, push down and hold the air bleed button until water flows from the hose and water leaks from the air bleed button. Do this for a minimum of 10 seconds and repeat this procedure 3 times.

Failure to prime the appliance will seriously affect the shower performance!

Note: Water will leak from bleed button.

Carefully dry off water before connecting / reinstating the electrical supply.

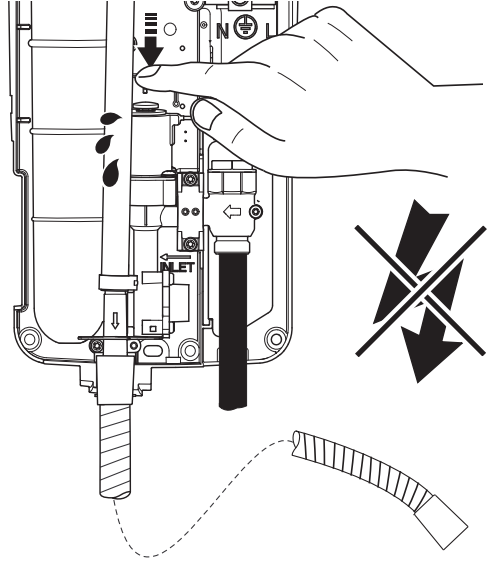

10

N = Blue or Black

⊖ = Green or Yellow/Green

L = Brown or Red

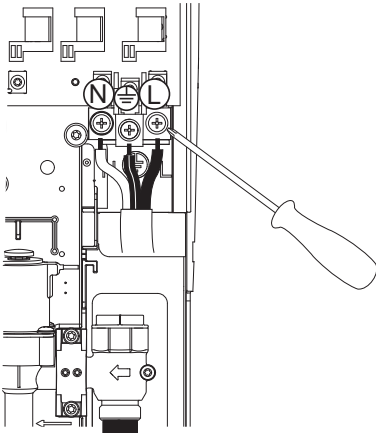

Feed the electrical cable into the case. Firmly connect the conductors.

DO NOT exert strain on the terminal block.

11

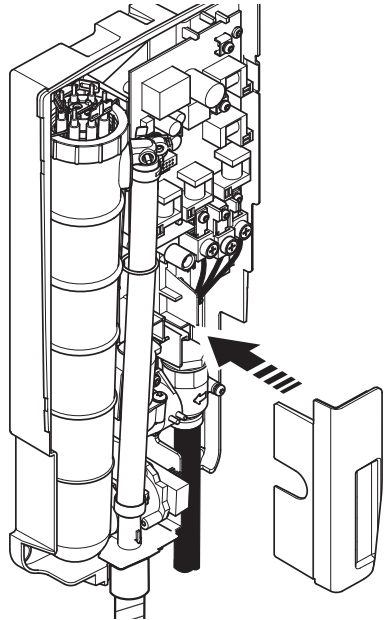

Refit the service tunnel.

Important! Refer to set up before fitting the front cover.

12 Setup

Maximum Temperature

You must set the product up to ensure it operates correctly for the users requirements. Factory setting with all switches in the off position at maximum temperature of 48° C. Please refer below for examples of settings.

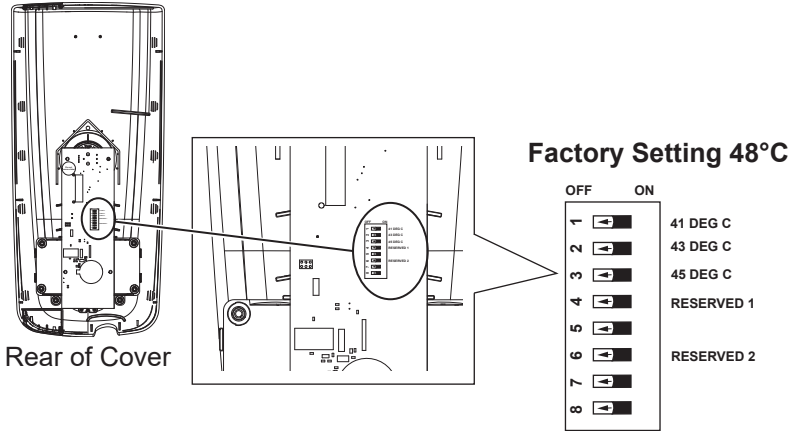

41° C

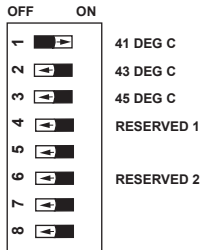

43° C

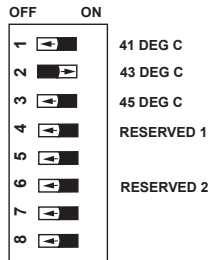

45° C

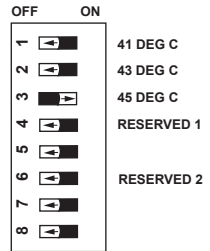

Post Installation Procedure

1



Turn on the electrical supply.

2

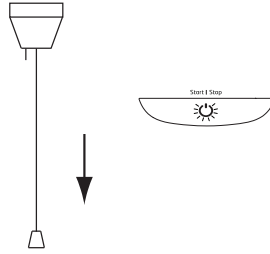

Turn on the power to appliance, check **Start/Stop** for white light.

3

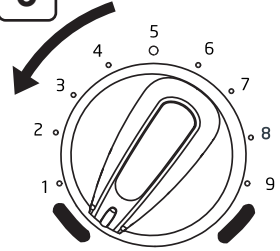

Turn the temperature to full cold.

4

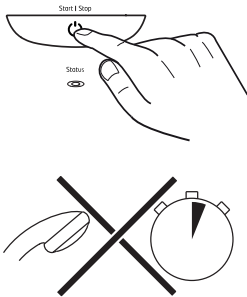

5 secs

Start the shower to test for water flow and run for at least 1 minute. If there is no water after 5 seconds, make sure that appliance has been primed.

5

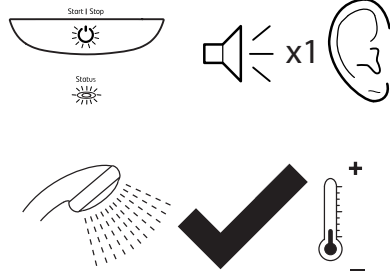

The shower will beep once when start/stop button is pressed. The white start/stop and blue status light will pulse and shower will beep again. After a few seconds the shower will beep again and the lights will go solid. This will confirm flow and cold temperature.

6

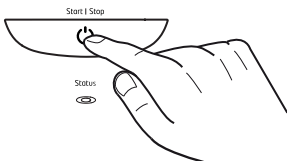

Push **Start/Stop** to turn off appliance. Pulsing start/stop light and "beep" indicates that appliance is shutting down.

7

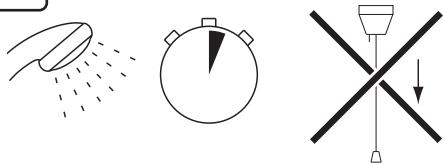

Appliance will purge water from heater tank for a few seconds.
Important! DO NOT isolate power until water has stopped.

Post Installation Procedure (Continued)

8



Turn on the electrical supply.

9



Turn on the power to appliance, check **Start/Stop** for white light.



10

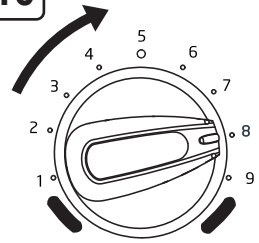

Turn the temperature control to number 8.

11

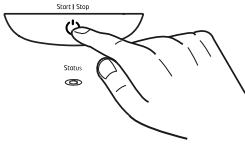

Start the shower to test for water flow. The shower will beep once and the white start/stop light and orange status light will pulse. Wait until the lights go solid and the shower will beep again.

12

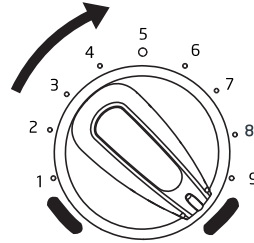

Turn the temperature control to the full hot position and continue to run the shower for at least 1 minute. The flow rate may vary during operation, and clicking sound may be heard from the product. This is normal.

13

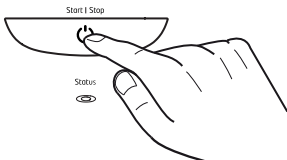

Push **Start/Stop** to turn off appliance. Pulsing start/stop light and "beep" indicates that appliance is shutting down.

14

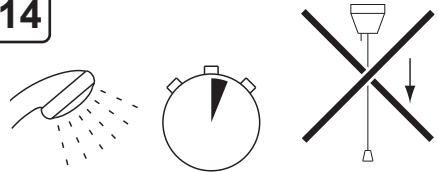

Appliance will purge water from heater tank for a few seconds.

Important! DO NOT isolate power until water has stopped.

This completes the installation of the Mira Advance Heatloop. Please advise the user how to operate their new shower and confirm that their shower is connected to a WWHRS.

Operating the Shower

Read the section: 'Important Safety Information'.

1

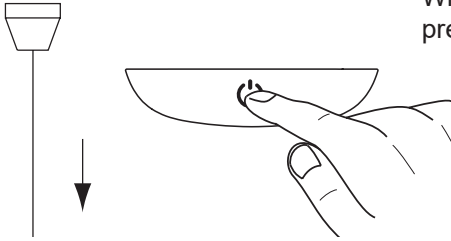

With the electrical supply turned on, press **Start/Stop**.

2

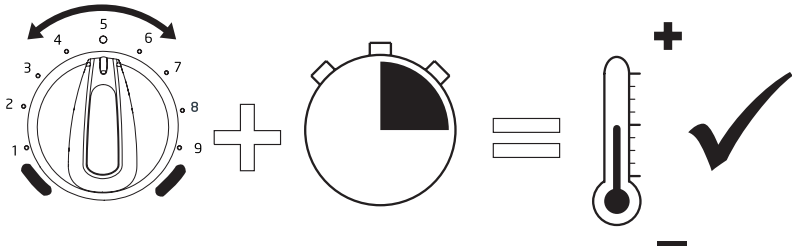

Adjust the temperature and allow approximately 30 seconds for any temperature adjustments to reach the showerhead.

The start/stop and status lights will pulse while getting up to temperature, and a clicking sound may be heard. Once the temperature is reached, the shower will beep, and the lights will stop pulsing.

3



Check water temperature before entering shower.

Important! This product is connected to a WWHRS to save the energy. This type of system will deliver a warmer inlet temperature to the shower and changes to flow may occur to keep the temperature stable and clicking sounds may be heard.

Note: The shower temperature can be adjusted to deliver a fully cold temperature. Due to the nature of a WWHRS, a cool shower (slightly warmer than a full cold) may not be possible due to the warmer shower inlet temperatures.

4

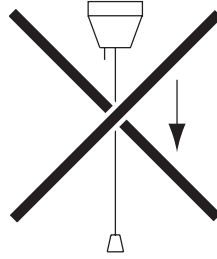
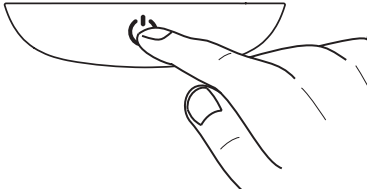

Press **Start/Stop** to shut down the shower. The pulsing start/stop light and "beep" indicates that the shower is shutting down.

Important! DO NOT isolate the power to the shower.

5

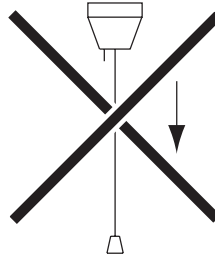
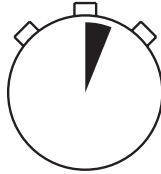

The shower will purge water from its tank for a few seconds.

Important! DO NOT isolate the power to the shower.

6

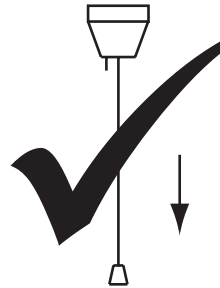
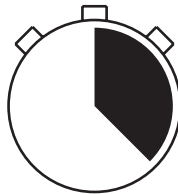

Wait until the water has stopped flowing and isolate the power to the shower, residual water may drain over a few minutes.

Failure to wait for the shower to purge warm water from the tank before isolating the power may cause the shower to go into an Error mode (Fault code M).

User Maintenance

Always read the IMPORTANT SAFETY INFORMATION for your shower.

In the event of a malfunction of the shower, a fault finding table is provided in this guide detailing possible causes and remedies that may be carried out by non-qualified personnel.

WARNING! TO REDUCE THE RISK OF FIRE, ELECTRIC SHOCK, INJURY OR PRODUCT DAMAGE:

1. There are no user serviceable parts inside the shower. Only qualified, competent personnel should remove the front cover, mains connections are exposed when the cover is removed.
2. Switch the shower off at the isolator switch before performing any user maintenance or before cleaning the shower.

Cleaning the showerhead

Many household and commercial cleaners, including hand and surface cleaning wipes contain abrasive and chemical substances that can damage plastics, plating and printing and should not be used. These finishes should be cleaned with a mild washing up detergent or soap solution, and then wiped dry using a soft cloth.

De-scaling the Showerhead and inspecting the hose:

It is IMPORTANT to keep the showerhead and hose clean and free from blockage to make sure your shower performs to its optimum. The showerhead MUST be regularly cleaned and the hose MUST be regularly inspected to ensure there is no internal collapse or blockage that could reduce the flow.

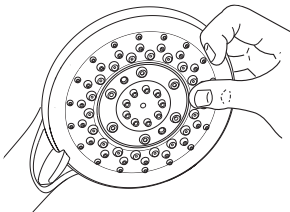

Use your thumb or a soft cloth to wipe any limescale from the soft nozzles

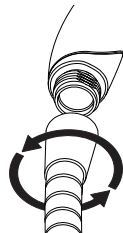

Unscrew the hose from the showerhead and the shower outlet.

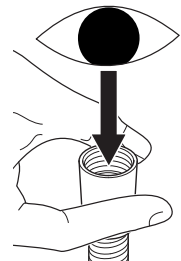

Inspect the hose.

Warning! Failure to keep the showerhead nozzles clear or inspect the hose for blockage or internal/external collapse can restrict the flow rate from the shower. This may cause damage to the shower or result in the temperature delivered to the user rising to unsafe levels with a risk of scalding. You MUST ALWAYS check the temperature before using the shower.

Fault Diagnosis

Warning! There are no user serviceable components beneath the cover of the shower. Only a competent tradesperson should remove the front cover. We recommend any maintenance work is carried out by a Mira service Engineer or similarly qualified tradesperson.

Installer Troubleshooting Guide

Refer to section: '**Important Safety Information**'.

The following troubleshooting solutions may require the removal of the cover of the shower. The cover should only be removed by a competent tradesperson and when doing so they should be aware of the following:

- Isolate the electrical and water supplies before initially removing the cover.
- Make sure Ribbon Cable is disconnected when removing the front cover and reconnect when maintenance is complete.
- Mains connections are exposed when the cover is removed.
- Refer to wiring diagram before making any electrical connections.
- Make sure all electrical connections are tight to prevent arcing/overheating.
- Make sure all plumbing connections are watertight.

When following these instructions, it is sometimes necessary to examine the appliance with the electrical and water supplies turned **on**. It is therefore essential that the appropriate safe working practices are followed in accordance with the current Health and Safety Legislation.

If conducting a continuity check using a multimeter, make sure the electrical supply is **ISOLATED**.



This product is connected to a Waste Water Heat Recovery System and therefore subject to changes in inlet water temperature. To ensure the temperature remains stable the shower may change in flow rate, this is normal and not a fault.





It is important to ensure the Waste Water Heat Recovery System (WWHRS) is maintained to ensure maximum efficiency. Refer to the WWHRS manufacturer's instructions for cleaning information.

Diagnostic Procedure

1. Ensure the shower pull cord / isolator switch is initially turned **OFF**, then turn **ON** the pull cord / isolator switch.
2. Start the shower and observe light fault indication (if any) and refer to Error Codes to determine failure and rectify.
Note: If the shower operates normally run the unit for at least 5 minutes at showering temperature and ensure the temperature remains stable.
3. Turn the shower off at the Start / Stop Button and observe 'phased shutdown'. **DO NOT** isolate the power at the pull cord / isolator switch until the water flow stops and the lights on the shower stop pulsing
4. **Show the user the correct start / stop procedure and general operation of the shower. Advise user that isolating the shower before the flow has stopped may damage the shower and will not start up correctly for the next use resulting in fault code M.**

Error Codes

Fault Indication				
Start/Stop	Status	Code	Cause	Initial Action
Flashing 	Flashing Red	A	No water supply Low pressure Blockage or restriction	Confirm water turned on. Check water pressure. Check filter, hose, showerhead and bleed valve.
	Flashing Red Yellow	D	Over temperature detected by the outlet thermistor	Purge the flow valve 3 x 10 secs, ensuring cold water coming from the showerhead.
	Flashing Red Blue	F	Over temperature detected at the inlet	Cold water supply is above the maximum temperature.
	Flashing Red White	I	Software Error	Power cycle the unit.
	Flashing White	M	Incorrect Shutdown	Wait 15 seconds until the lights stop flashing before attempting to start the shower. Ensure shower always turned off correctly to prevent recurrence.
Should the fault remain after the initial action, press and hold the 'Start/Stop' button and note the Status light sequence.				
Off 	Flashing Red Blue	Flow Valve fault		Contact customer services.
	Flashing Red Yellow	1. Check thermistor connection (CN3) to the relay board. 2. Thermistor failed in heater tank.		Contact customer services.
	Flashing Red White	Cover PCB failure		Contact customer services.

Fault Indication				
Start/Stop	Status	Code	Cause	Initial Action
On 	Flashing Red Blue	G	Start/Stop button stuck	Contact customer services.
	Flashing Red White	J	Relay Board failure	Contact customer services.
Should the fault remain after the initial action, press and hold the 'Start/Stop' button and note the Status light sequence.				
Off 	Flashing Red White	Cover PCB failure		Contact customer services.
Off 	Flashing Red Yellow	C	Thermistor fault	Check thermistor connection (CN3) to relay board. Contact customer services.
	Flashing Red Blue	E	Flow Valve fault	Contact customer services.
	Flashing Red White	H	Cover PCB failure	Contact customer services.
	Off	L	Electrical Fault	Check power to the shower
Should the fault remain after the initial action, press and hold the 'Start/Stop' button and note the Status light sequence.				
Off 	Flashing Red White	Cover PCB failure		Contact customer services.

Additional Notes:

Shower Temperature - If the shower maximum temperature is too cold or too hot, check the configuration of switches. Refer to section - **SET UP**.

This product is connected to a WWHRS. Changes to the water flow rate may occur, and it is normal to ensure temperatures remain stable.

Maintenance

Tradesperson Maintenance - Inlet Filter Cleaning/Replacing

Read the section 'Important Safety Information' first.

1

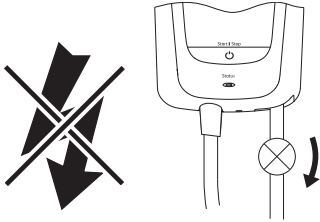

Electrical and water supplies to appliance are turned off.

2

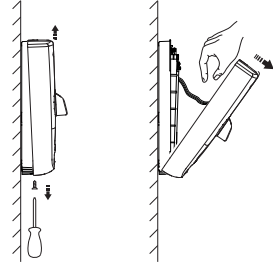

Remove cover screw, cover and splash guard. Disconnect ribbon cable from cover

3

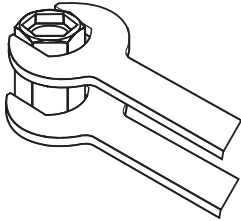

Hold a spanner or other suitable grips across flats of the metal connector. Unscrew filter using another spanner as shown. Clean or replace filter as necessary. Refit filter making sure it is screwed fully home. **Do not overtighten.**

4

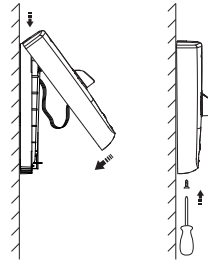

Make sure all plumbing connections are sealed before restoring water supply. **Re-prime appliance** (refer to 'Installation') before restoring electricity supply. Refit splash guard, ribbon cable and cover.

Spare Parts

Warning! If the wiring layout is changed or amended, the product functionality and safety may be affected. In the interests of safety, spares requiring exposure to mains voltage should only be fitted by competent persons.

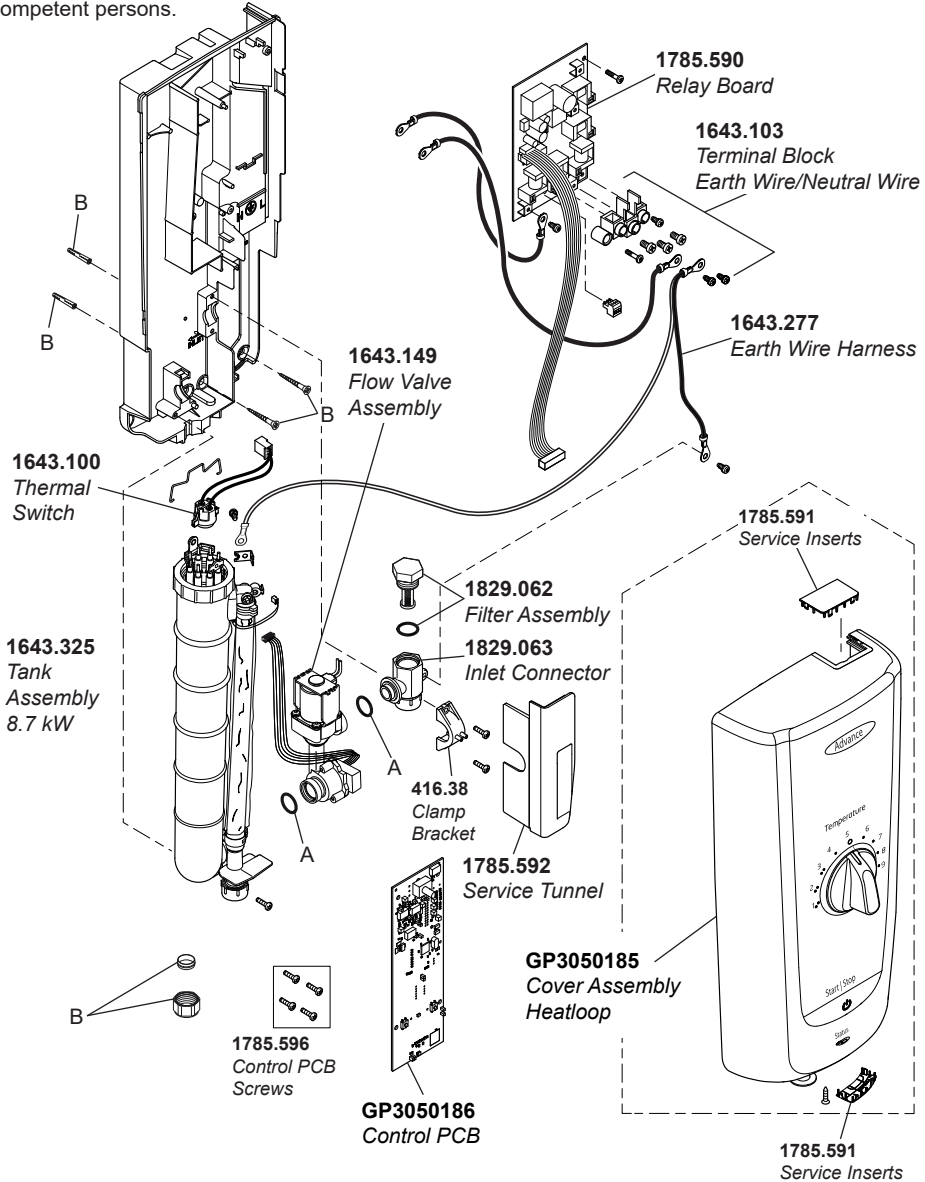

1643.113 Component Pack (components identified 'B').
1643.148 Seal Pack (components identified 'A').

Customer Support

Guarantee

Your product has the benefit of our manufacturer's guarantee which starts from the date of purchase. This guarantee only applies in the United Kingdom and Republic of Ireland.

Activating Your Guarantee

Registering your guarantee is quick and simple. To ensure your product is covered, please register online.



Scan the QR code to activate your guarantee now or call 0800 5978551 within 30 days of purchase (UK only).

What is Covered:

- The guarantee applies solely to the original installation under normal use.
- The product must be installed and maintained in accordance with the instructions given in this guide.
- Servicing must only be undertaken by us or our appointed representative.
- Repair under this guarantee does not extend the original expiry date. The guarantee on any replacement parts or product ends at the original expiry date.
- For shower fittings or consumable items we reserve the right to supply replacement parts only.

The guarantee does not cover:

- Call out charges for non product faults (such as damage or performance issues arising from incorrect installation, improper use, inappropriate cleaning, lack of maintenance, build up of limescale, frost damage, chemical attack, corrosion, system debris or blocked filters) or where no fault has been found with the product.
- Water or electrical supply, waste and isolation issues.
- Routine maintenance or replacement parts to comply with the requirements of Building / Plumbing / Electrical Standards or Schemes.
- Compensation for loss of use of the product or consequential or indirect loss of any kind.
- Damage or defects caused if the product is repaired or modified by persons not authorised by us or our appointed representative.
- Accidental or wilful damage.
- Products purchased ex-showroom display.
- Disinfection or descaling to reduce bacterial growth or contamination.

What to do if something goes wrong

If your product is not working correctly please refer to this manual or the Mira website for fault diagnosis and to check that it is installed and commissioned in accordance with our instructions. If this does not resolve the issue, our Customer Services team are here to help get you back up and running. To help us solve your problem quickly, please have your product name, power rating (if applicable) and date of purchase to hand.

Visit www.mirashowers.co.uk

Visit our website to register your guarantee, book a service visit, diagnose faults and purchase products.

Spares and Accessories

We stock a full range of spare parts and fittings and are all available to purchase either online or over the phone. Our online spare parts selector tool will help you quickly and easily identify the spare part for your product.

Visit www.mirashowers.co.uk/parts-accessories

Replacements and Repairs

In the unlikely event that your product needs a repair, our nationwide repairs and installation team are here to help. You can book a convenient date and time online.



Scan the QR code to book a service visit now or visit www.mirashowers.co.uk/support/repair-services/repair-service

We also offer a comprehensive replacement service for when your product needs a little refresh, visit our website or contact our team for more information on our replacement services.

Help us improve

Your experience is important to us and your review (whether good, bad or otherwise) will be posted on Trustpilot.com immediately to help other people make more informed decisions.

Visit uk.trustpilot.com/review/www.mirashowers.co.uk

Need to get in touch?

UK

T: 0800 001 4040
E: askus@mirashowers.com
www.mirashowers.co.uk

Eire

T: 01 531 9337
E: customerserviceire@mirashowers.com
www.mirashowers.ie

Mira is a registered trade mark of Kohler Mira Limited.

The company reserves the right to alter product specifications without notice.

Registered Office:
Cromwell Road,
Cheltenham,
Gloucestershire
GL52 5EP

EU Importer address:
Kohler France S.A.S.
30 Boulevard de la Bastille,
75012 Paris,
France



mira
SHOWERS