

WL6007##H
WL6008##H
WL6009##H
WL6018##H
WL6019##H
WL6021##H
WL6022##H
WL6024##H
WL6104##H
WL6105##H



Always follow the instructions provided to ensure that your product is assembled and fitted safely, and retains its high quality finish.

ALWAYS RETAIN THIS MANUAL FOR FUTURE REFERENCE

WHAT TO KNOW BEFORE INSTALLING...

1. When positioning the seat onto the pan ensure that the lid and ring can be lifted independently and remain upright on the pan.
2. Before fully sticking the adhesive tape to the pan, ensure the toilet seat is in a perfect position as it can be difficult to reposition when the tape has adhered to the ceramic.
3. To remove the flexi fit bracket at the end of its use, use a plastic scraper to carefully lever the hinge away from the toilet pan.

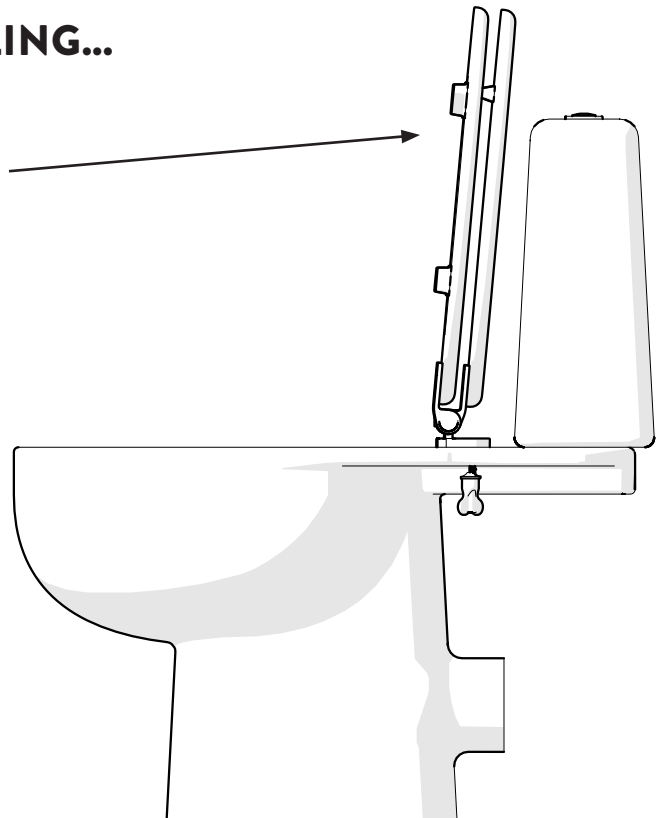

PLEASE READ ALL OF THE INFORMATION CAREFULLY AND REFER BACK WHEN YOU SEE THE NUMBERED ICONS THROUGHOUT INSTRUCTIONS.

SAFETY & PRODUCT CARE

1. To retain the best quality finish, clean product with a soft cloth and a mild soap solution applied directly to the cloth.
2. **DO NOT** use abrasive or chemical cleaners as they may damage the surface of the toilet seat or hinges.
3. To remove the flexi fit bracket at the end of its use, use a plastic scraper to carefully lever the hinge away from the toilet pan.

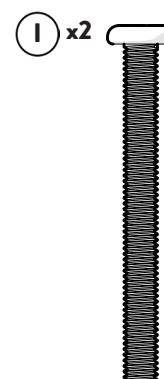
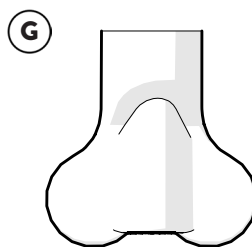
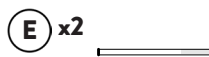
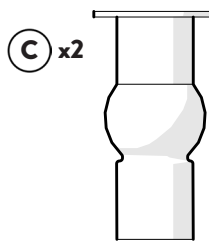
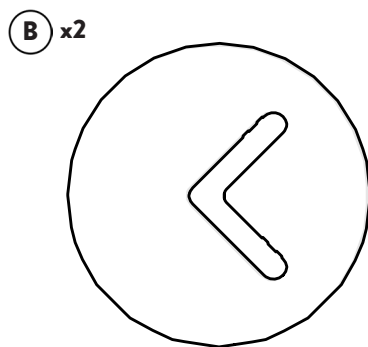
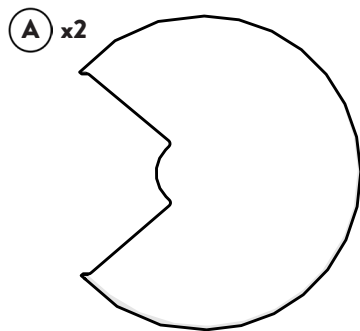

1. BEFORE YOU BEGIN

PREPARATION

1. Remove the old seat from the pan and clean the surface around the fixing holes.
2. Ensure the surfaces around the fixing holes are completely dry and free of any dust or debris before beginning the installation.
3. To ensure you do not lose any dropped components in the toilet pan, place cling film over the toilet bowl.
4. Ensure the red protective film has been peeled off the tape on the underside of the flexi fit bracket before mounting the hinges. Do not fully stick the hinges in place until the desired position of the seat has been achieved.

2.

Remove the decorative and protective caps from the hinges.

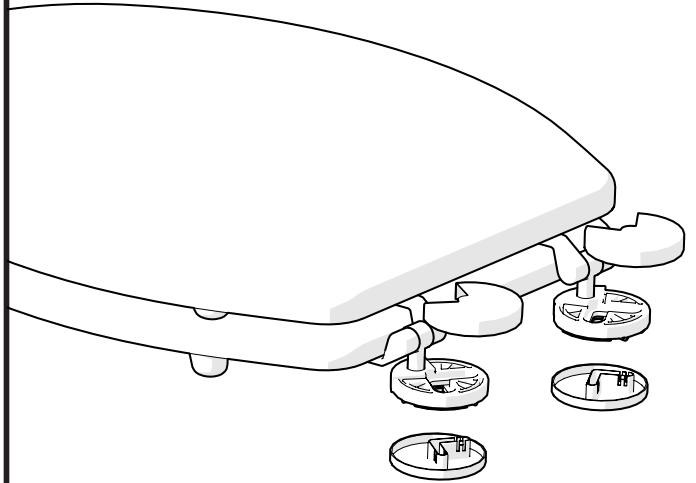

3.

3a.

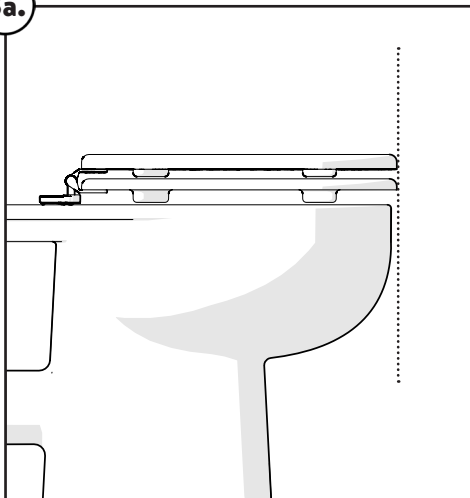

3a. Align the seat with the front of the toilet pan.

3b. Choose the slot which best suits the position of the toilet seat on your toilet pan.

3b.

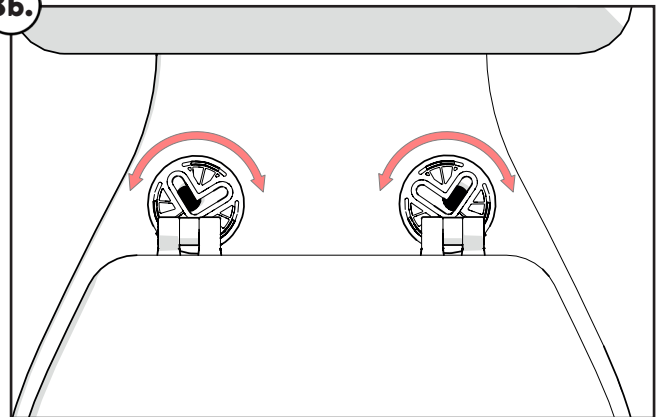

3b.

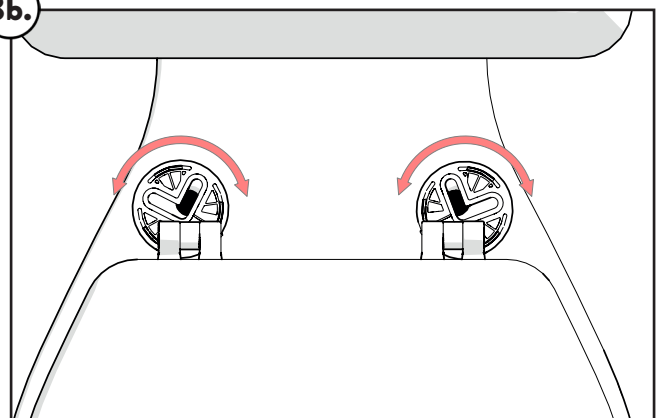

*Hinge positions should be symmetrical.

4.

Remove the protective film to reveal the grip pad and place bolts into the hinge base.

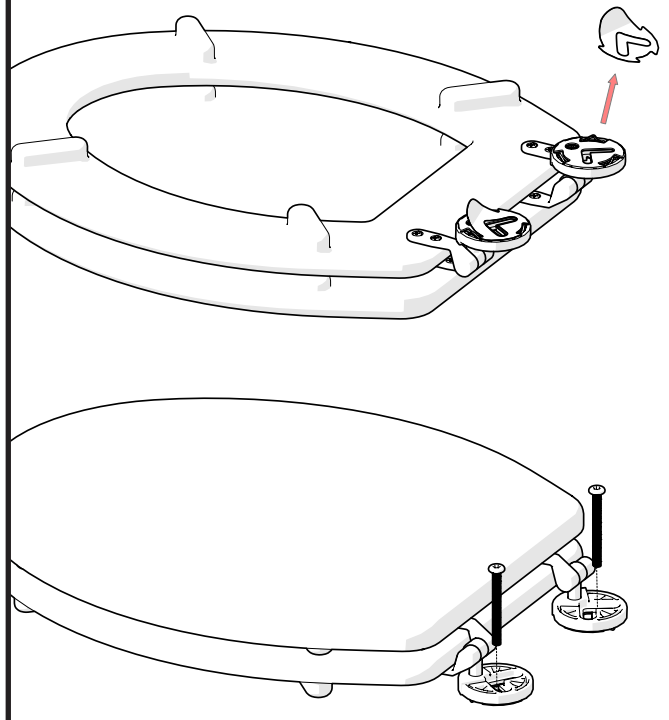

5.

TOP OR BOTTOM FIXINGS?

TOP FIX

- Fits most toilet pans.
- Suitable for back to wall pans.
- No need to reach underneath the toilet pan.

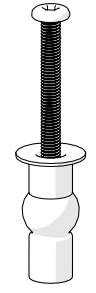

OR

BOTTOM FIX

- Faster installation.

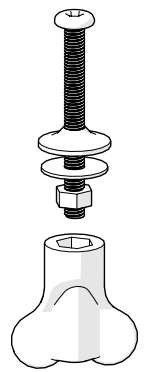

6.

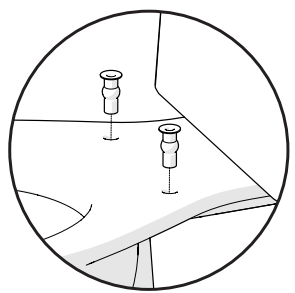

For top fix, insert the rubber plugs into the holes in the toilet pan.



IMPORTANT! Carefully place the seat on the pan ensuring the Grip Pad does not stick to the pan surface at this stage of installation.

7.

Lightly screw the bolt into place using your chosen fixing method. Do not collapse the supports on the hinge base yet.

BOTTOM FIX

TOP FIX

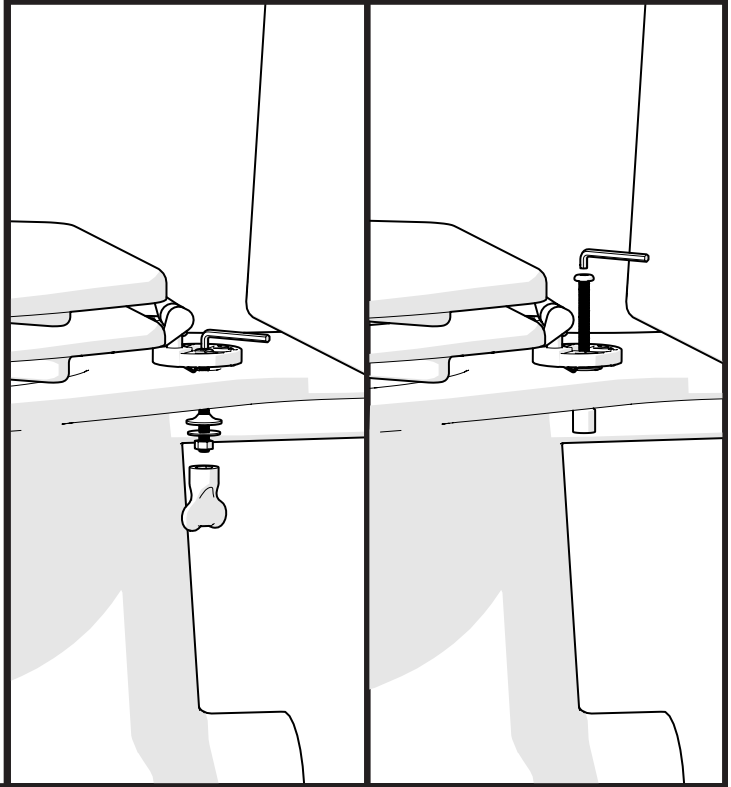

8. When the desired position of the seat has been achieved, apply firm pressure on both flexi fix brackets so the adhesive pad makes contact with the pan.
Hold for at least 20 seconds.

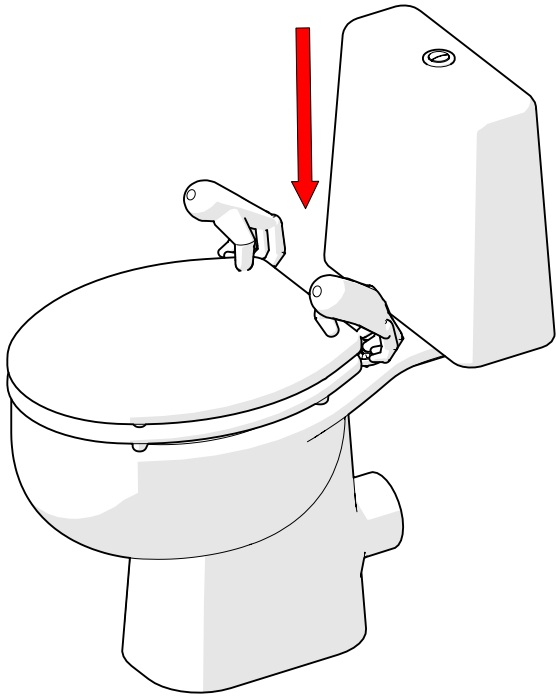

9. **Fully tighten** the bolt using your preferred fixing method.

BOTTOM FIX

TOP FIX

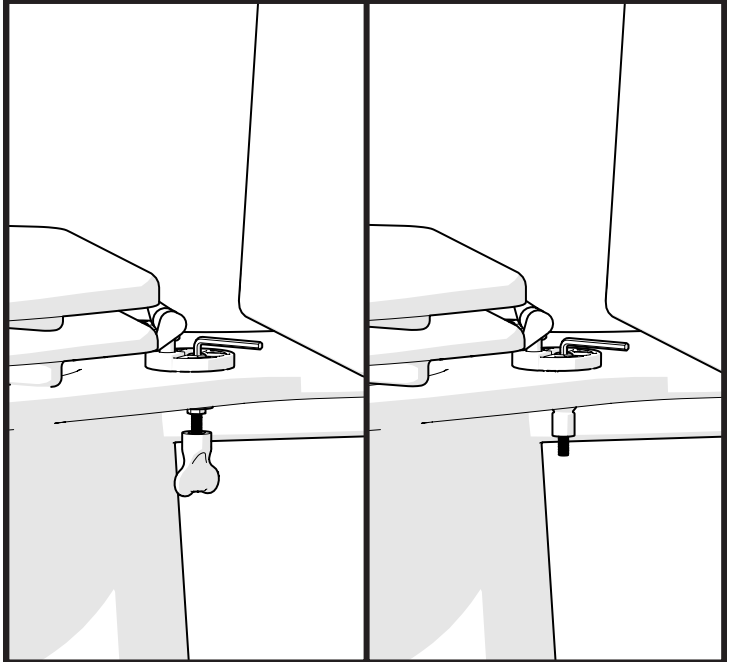

NOTE: If you need to lift the seat to access the bolt, ensure you do not move the hinges.

10. Place on the decorative covers.

